



CONSTRUCTION  
INDUSTRY COUNCIL  
建造業議會

# GYROSCOPIC STABILIZERS FOR CONSTRUCTION CRANES AND GONDOLAS



## RESEARCH SUMMARY





## Authors

Prof. Andrew Y. T. LEUNG  
Dr Jiayu CHEN  
City University of Hong Kong

## Published by

Construction Industry Council,  
Hong Kong SAR

# DISCLAIMER

The information given in this report is correct and complete to the best of knowledge of the authors and publisher. All recommendations are made without guarantee on the part of the authors or publisher. The authors and publisher disclaim any liability in connection with the use of the information given in this report.

## Enquiries

Enquiries on this research may be made to the CIC Secretariat at:

CIC Headquarters  
38/F, COS Centre, 56 Tsun Yip Street, Kwun Tong, Kowloon

Tel.: (852) 2100 9000

Fax: (852) 2100 9090

Email: [enquiry@cic.hk](mailto:enquiry@cic.hk)

Website: [www.cic.hk](http://www.cic.hk)

© 2018 Construction Industry Council.



# FOREWORD

Every year, incidents related to construction crane are reported, and about half of them are due to failure of stability or improper control of lifting appliances. The research need of the industry is well addressed by Professor Andrew LEUNG from the City University of Hong Kong. He proposed the installation of gyroscopic stabilizers to address the issue. Gyroscopic stabilizers have been widely used in aeronautical and marine industries, and have exhibited great success in mitigating rotation and vibration.

The research work presented in this report was funded by the CIC Research Fund, which was set up in September 2012 to provide financial support to research institutes/construction industry organizations to undertake research projects which can benefit the Hong Kong construction industry through practical application of the research outcomes. The CIC believes that research and innovation are of great importance to the sustainable development of the Hong Kong construction industry. Hence, the CIC is committed to working closely with industry stakeholders to drive innovation and initiate practical research projects.

In the research project, the research team investigated the mathematical modeling and dynamics of crane and the hoisting system, and then proposed a hybrid control system integrating both mechanical and electrical gyroscopes. A prototype was then built and tested in laboratory. The test results were useful to validate the effectiveness of the proposed system in controlling rotation and vibration of payload. The result was encouraging and laid a solid foundation for its practical application.

This project cannot succeed without the dedicated efforts of Professor LEUNG and the research team. Their contributions are gratefully acknowledged. The CIC would also like to work with the research team and industry stakeholders to further develop the technology and put it into real application.

***Ir Albert CHENG***

Executive Director

Construction Industry Council



# PREFACE

Construction is a traditional and prosperous industry through the history. It always poses challenges requiring endeavors from engineers, practitioners, and scholars. As a densely populated and booming city, Hong Kong has the largest number of skyscrapers. With the industrialization in construction industry, more and more building modules are built in factory and shipped to the construction site in good time. Most building materials and components, such as steel beams and precast concrete panels, are generally conveyed to the right position using tower cranes. The number of cranes at each construction site is limited and the operation efficiency of each crane influences the speed of construction. The load on a crane can move freely in the horizontal plane because the crane cable is long and flexible, exhibiting no torsional resistance. Thus, the load can be easily rotated by external disturbances, such as wind and inertia reactions, accompanied by crane boom slewing and movement of the crane itself. Once load rotation takes place during transportation, the rotation cannot be suppressed, and the load cannot be mounted at the setting position, so the transportation must be temporarily interrupted. In fact, at several construction sites, including high-rise buildings and buildings facing the sea where strong winds often occur, transportation is frequently delayed. In the worst cases, the work can be delayed all day. Conventionally, load rotation is eliminated by pulling assistant ropes hooked to the load, but these additional operations are dangerous and time-consuming. Therefore, there has been a strong demand for construction site operators to find a way to suppress load rotation.

Historically, gyroscopic stabilizers have been widely used in aeronautic and marine industries and recently are popular technologies used in mobile phone, camera, car and drone. Gyroscopic stabilizers in the project consists of at least three parts: sensors to notice the undesired disturbance; a control system to make decision; and an actuator. Both the sensor and the control system can be achieved electronically. The actuator is a gyroscope giving the required stabilizing moment to suppress the undesired rotation. The amount of the stabilizing moment provided by gyroscopes is a function of the flywheel inertia, the angular velocity of the flywheel, and the angular velocity of the gimbal frame.

Since the gyroscopic stabilizer cannot control the translational movement of the pay load, air jet can be used as an additional actuator to provide translational control. A suspender device activated by a gyroscope and air jet has been developed. Applying the suspender device to construction work, the cycle time for vertical load transportation can be effectively reduced. It is expected that the device will find many applications in construction industry.

The support from the Construction Industry Council is undoubtedly the indispensable essence for the realization of this research. It is believed the research collaboration among the Construction Industry Council, learned societies and industry practitioners will benefit the society.

***Prof. Andrew Y. T. LEUNG***

Department of Architecture & Civil Engineering  
City University of Hong Kong

# RESEARCH HIGHLIGHTS

Tall and flexible construction cranes are unique in Hong Kong, since it enables low cost and rapid construction of high buildings. Advanced prefabricated construction requires tower cranes to lift heavy components to precise locations at specified heights. Gondolas are popular for cleaning and maintaining tall buildings. Both the equipment and the hoisting line of the crane are extremely difficult to maneuver under heavy wind, traffic and construction loads. Any undesirable movements of the crane and the payload could be hazardous. For safety reasons, when erratic behavior is detected, any operation is required to be halted, which will prolong construction time and increase construction costs. So far, there is no satisfactory solution to stabilize cranes and their payload due to the substantial energy requirement.

A gyroscope is a device consisting of a rapidly spinning wheel set in a framework that permits it to tilt freely in any direction. The momentum of the wheel causes it to retain its attitude when the framework is tilted. When the gyroscope rotates along its plane, the resulting motion produces a gyroscopic torque that keeps it in the desired direction. A number of valuable applications in spacecraft navigation, ship stabilization and aircraft instruments can be derived from these unique characteristics. Therefore, this project aims to provide a practical solution to stabilize construction cranes with gyroscopic devices.

The dynamics of the crane, hoisting line and stabilizer are extremely complicated. Before designing a stabilizing device, the dynamics of the system must be studied comprehensively, then a laboratory model with the necessary controllers must be constructed to make a prototype. The final product is a light weight gyroscopic unit with built-in control technology to produce a balancing torque, keeping the system in the desired direction. The magnitude of the torque is mainly controlled by the spinning rate and not necessarily by the weight of the device.

Vibration of the crane frame and the girder under high winds also can be minimized using vibration neutralizers that the principal investigator developed for the lamppost on the Tsingma Bridge. The applicability of this device to the construction industry depends primarily on the successful lobbying to the insurance industry.

# CONTENTS

<b>1</b>	<b>INTRODUCTION</b>	<b>1</b>
1.1	Background	1
1.2	Research Aim and Objectives	2
1.3	Key Issues and Scope of the Research	3
<b>2</b>	<b>RESEARCH METHODOLOGY OVERVIEW</b>	<b>5</b>
<b>3</b>	<b>RESEARCH FINDINGS AND DISCUSSION</b>	<b>9</b>
3.1	Dynamics of the Crane and Hoisting System	9
3.2	Design of Stabilizing System	9
3.3	Electrical Control System	15
3.4	Simulation for the Control System	19
3.5	Design of the Final Prototype	21
<b>4</b>	<b>CONCLUSION AND RECOMMENDATIONS</b>	<b>23</b>
4.1	Conclusion	23
4.2	Recommendations	23
<b>5</b>	<b>REFERENCES</b>	<b>25</b>

# 1 INTRODUCTION

## 1.1 Background

Tall and flexible tower cranes are widely utilized on construction sites, but natural sway of payloads is nearly unavoidable. Besides, environmental wind is the major external disturbance source of crane loads, which leads to additional sway. Supporting structures and hoisting lines of a tower crane sometimes are too maneuverable to withstand strong wind, over torques and heavy load (Leung 1983). Especially, prefabricated building components and materials require tower cranes to lift heavier load to more precise locations at specified heights. In addition, strong wind in construction sites put construction workers in danger. For safety reasons, tower crane operation must be halted when the wind speed exceeds 20 m/s (Winn *et al.* 2005). Therefore, any undesirable movement of crane load will prolong construction schedule and increase construction risk.

According to the passive control of convey-cranes (Collado *et al.* 2000), the oscillation of crane load and hoisting system can be assumed as an inverted pendulum. Then the hoisting system is divided into two parts. One part is the rigging connection between trolley and hook assumed as flexible; other part is the cable that links hook and payload and it can be assumed as rigid. Considering piece-wise connection among trolley, hook, and payload, such structure has significant impacts on stabilization.

In this project, we tried to explore the four major parameters (swing angular velocity, swing angular acceleration, payload position velocity, and payload position acceleration) and to understand the relationship between crane load and external wind through simulation. Based on the simulation model, a hybrid control mechanism with electronic and mechanical gyroscopes was developed, and a wind tunnel test was conducted to validate the hybrid control mechanism.



## 1.2 Research Aim and Objectives

The primary aim of this research is to design a feasible gyroscopic stabilizer for construction cranes to minimize cargo pendulation and swinging. Thus, we divided our research as following objectives:

- Review existing devices that control construction crane payload swinging and gondolas pendulation.
- Investigate the mathematical modeling and dynamics of the crane and hoisting system.
- Study the nonlinear dynamics of a gyroscope.
- Apply the controlling devices for the gyroscopically stabilized crane system.
- Assess the limitations and risks of the use of gyroscopes in construction cranes.
- Build a laboratory model to demonstrate the effectiveness of the system.

## 1.3 Key Issues and Scope of the Research

The stability of a construction crane system in operation is characterized by the following factors: (1) the amount of payload, which influences the static stability and the natural frequency of the spherical pendulation; (2) the variable distance from the crane shaft to the hoisting point; (3) the movement velocity of the payload; (4) the swing of the girder. The wind load is a dependent force relying on the deflection of the hoisting cable and other environmental forces - foundation under ambient excitation. Tuned mass damper alone would not work independently, as the system has an array of natural pendulation frequencies. Although a gyroscope can provide the desired stabilizing moment and variable-tuned frequency, the gyroscopic moment would certainly complicate the system. Therefore, it is crucial to establish a theoretical framework, when designing a laboratory model. A stabilizer is beneficial to the construction industry, since it is able to speed up the construction process and reduce risks during construction and maintenance.

Cranes are used in nearly every construction project, yet there is still no satisfactory solution to mitigate the dynamic instability problems (Leung 1978, 1991). The gyroscopic stabilizers which have been successfully implemented in the past century in aerospace and related industries have not been tried on construction cranes yet. This project intends to minimize crane accidents, prolong fatigue life and improve productivity in tall building construction and maintenance - particularly in Hong Kong.

Two types of motion stabilization are required for construction cranes: swing and rotation. As demonstrated in Figure 1, the longitudinal direction is taken as the y axis and the vertical direction is taken as the z axis such that the arrangement of x-y-z forms the right handed Cartesian axes. The corresponding angular coordinate system is Pitch-Roll-Yaw. A control moment gyroscope (CMG) is able to produce anti-angular torque automatically to prevent specific movements. The movements of the payload to be prevented are all rotations and translations - except the z translation movement. Translation along the x direction can be prevented by controlling Roll and along y by controlling Pitch. CMG can have single gimbal (Figure 1 c), double gimbal (Figure 1 d), twin type (Figure 1 e), or other configurations for different economical and stability considerations

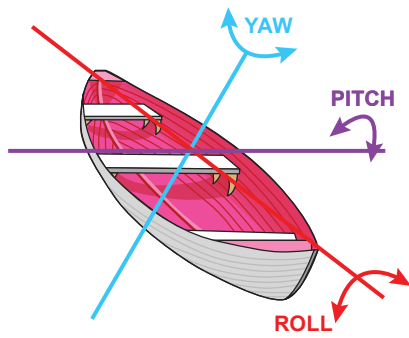

(a) Boat Terminology

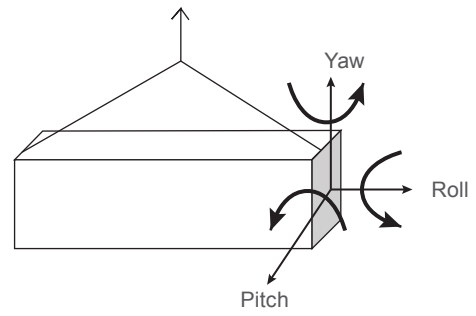

(b) Crane payload terminology

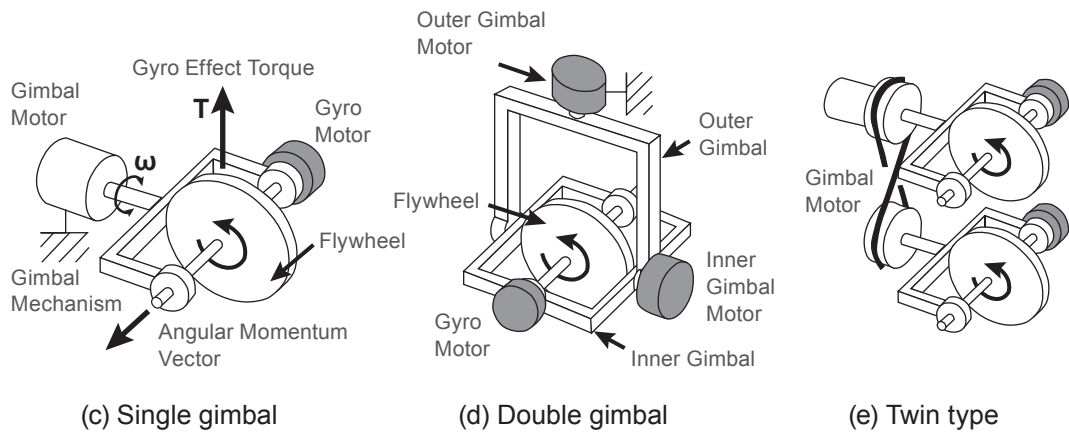

(c) Single gimbal

(d) Double gimbal

(e) Twin type

Figure 1 Configuration of gyroscope

# 2 RESEARCH METHODOLOGY OVERVIEW

## (a) Review the existing devices that control construction crane vibration and cargo pendulation

Although Abdel-Rahman (2003) has made a very comprehensive review on the topic, it is necessary to extensively and thoroughly review existing devices, if any, that control construction crane vibration of the tower / girder and cargo pendulation by searching literature and commercial web-sites (Leung and Fung 1990). When practicality is emphasized, the following references can be useful.

- [1] Kanki H, *Development of CMG Active Vibration Control Device for Gondola, Proceeding the First International Conference on MOVIC, 1992, pp 310 -315.*
- [2] Fumihiko Inoue, Kouji Wiuanabe, Yuichi Lkeda, Tatura Wakisaka, Akira Wakabayashi, Yoshitsugu Nekomoto, *A practical development of the suspender device that controls load rotation by gyroscopic Moments, Proceedings of the 15th ISARC, Munchen, Germany, Pages 486-495 (1998)*
- [3] Haruhisa Kurokawa, *A Geometric Study of Single Gimbal Control Moment Gyros, Report of Mechanical Engineering Laboratory, No. 175, p.108, 1998.*

## (b) Investigate the mathematical modeling and dynamics of cranes and hoisting systems

A construction crane consists of three main parts - a tower, a girder or a balance girder with counter-action weight, and the hoisting system with hanging cargo. In order to make the girder level horizontal, cables are usually fastened from the top of the tower to the ends of the girders. Since only the global behavior is of interest, the 2-level finite element method fits the purpose with a small number of degrees of freedom. To eliminate inertia instability, the motions of the girder swing and trolley translation are extremely slow. The hoisting system can be modeled as a spherical system using spherical coordinates in the case of stationary motion. When the girder and the trolley move fast, the hoisting system can be modeled as a spherical system with moving support. The resulting natural frequencies of important modes can be used in designing vibration neutralizers and counteracting gyroscopic torque (Ding *et al.* 2001; Leung and Zhang 1998a; b).

### **(c) Identify the causes of instability and predict various kinds of instability mathematically**

Static buckling of the tower and tipping of the girder are the primary concerns of the Occupational Safety and Health Administration (OSHA) of America. The dynamics of a spherical pendulum with fixed support can be studied by spherical coordinates. As the angular displacements of the hoisting line are small, the governing equations can be linearized. Wind load is the primary excitation force and is follower in nature. When the cargo is uplifted, the trolley moves and the girder swings; the resulting dynamic interaction phenomena becomes interesting. Various bifurcations were studied for various wind and motion speeds in this study. The phenomena of interest includes buffeting, limit cycle, flutter, galloping and bifurcation on a torus (Ge and Leung 1998; Sedaghat and Cooper 2002).

### **(d) Study the nonlinear dynamics of a gyroscope**

The governing equations of a gyroscope are analogous to that of the large deformation of a three dimensional flexible rod resembling the famous Kirchhoff analogy as in where various bifurcations of the system were studied (Chen and Leung 2012; Leung and Rajendran 1996; LEUNG and Rajendran 1996; Sedaghat and Cooper 2001). The dynamics of the gyroscope is further complicated by the fact that it is now mounted on a vibrating frame, subject to gusty wind. The interaction of tower, girder, hoisting and gyroscope is a challenging dynamical problem.

### **(e) Apply controlling devices for the gyroscopically stabilized crane system**

Three controlling actions of a gyroscope were studied in detail and applied to construction cranes: gyroscope inertia, gyroscopic torque and oscillogyro. The gyroscope inertia was used to measure the absolute angular movements at the trolley for controlling the leveling problem and to provide damping effects to the vibration (Leung 1993, 2001a; Ravindra and Mallik 1993; Richards and Leung 1977). The gyroscopic torque induced by the spin of the rotors and the swing of the girder is orthogonal to the spin and swing axes, and its intensity is proportional to the spin rate. An oscillogyro consists of a slender beam attached at its centre of mass by an elastic torsional spring to a gimbal which is driven at high speed about its axis of spin. The natural frequency is directly proportional to the spin rate. By adjusting the spin rate according to the trolley position and the height of the cargo, one can tune the natural frequency of the crane system and stabilize it (Leung 1992). For this task, a simulation model was developed to validate its performance.

## (f) Assess the limitations and risks of the use of gyroscopes in construction cranes

It is important to conduct a parameter study to find the range of applicability and the effectiveness of the gyroscopic stabilizer to find an optimal design. Extensive theoretical and experimental investigations were carried out and the limitations of using gyroscopic stabilizers in construction cranes were highlighted in this research. A foreseeable built-in limitation is the dead zone of the motor and the upper velocity limit which make it difficult for the stabilizer to respond to small angles or make timely adjustments. The research team acquired an advanced Anti-Rolling Gyro (ARG) for vessel use and modified it to fit our purpose. As the ARG (Figure 2) has a high-speed spinning flywheel, there is potential for a severe accident to occur if the ARG unit breaks. Thus, as a measure to address product liability, a destructive test simulating a failure mode should be conducted. This test was carried out by simulating a reduction in the damping force of the gimbal angular velocity control dampers to verify that no critical breakage would occur. In the development phase, a risk assessment based on the MIL-STD-882 and BS8800 was used to identify hazard sources. The results of the assessment were reflected in the design of the device, the instruction manual, and the warning labels.

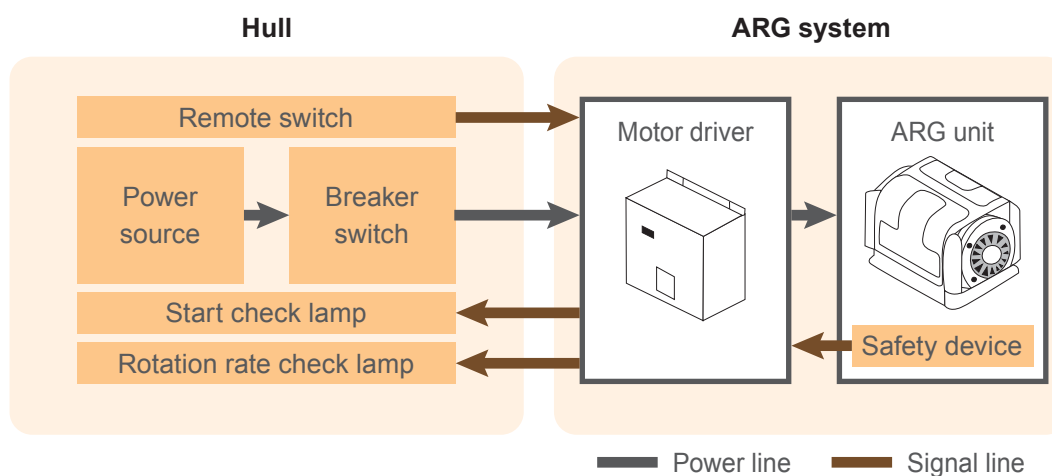

Figure 2 The ARG system configuration

### (g) Build a laboratory model to demonstrate the effectiveness of the system

A laboratory model of a construction crane was very similar to that of street lighting posts of T or Tau shapes with the addition of a mobile trolley on the girder where a hoisting system was attached. The natural frequencies in bending and torsion of the construction crane were important data for applying the similarity principle of modeling. Various kinds of gyroscopic devices were tested and the spin rate was controlled by hand using inverters. An experiment was developed to verify the theory and to demonstrate the effectiveness of gyroscopic stabilizers for construction cranes. Oscillogyros with variably tuned natural frequency were tested for the implementation in construction cranes. After the experiment, the research team recorded the natural frequency of the system when the trolley moves and uplifts and tied various positions to find out the proper location to maximize the stabilization. Figure 2 shows the suggested ARG system configuration. It consists of an electric power source, a motor driver, and an ARG unit. Electric power is supplied to the motor driver from an on-board generator through a breaker switch, and is used to drive a flywheel inside the ARG. This motor driver employs an inverter and exclusively serves the ARG unit. Figure 3 highlights the prototypes developed in this study.

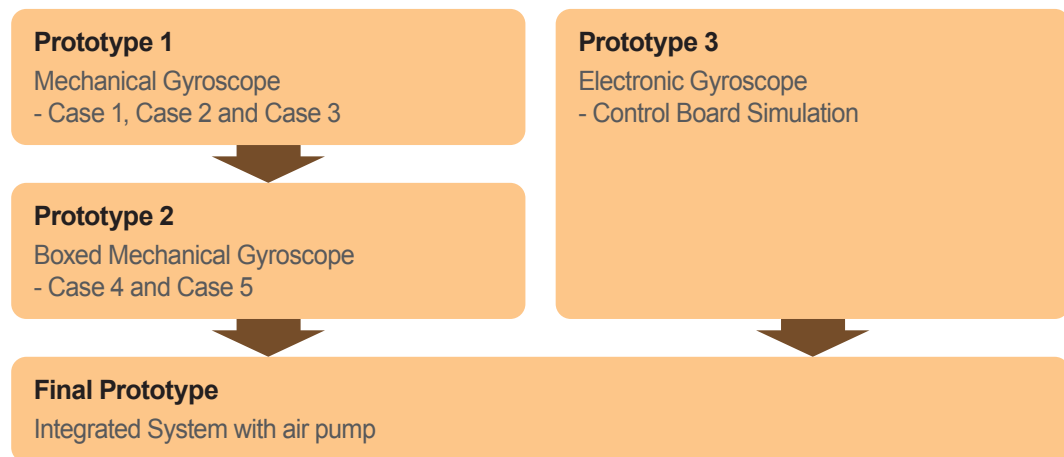

Figure 3 Multi-generation of models developed in this project

# 3 RESEARCH FINDINGS AND DISCUSSION

## 3.1 Dynamics of the Crane and Hoisting System

In this project, the hoisting system was modelled in both global and local systems. In a global system, a spherical system with moving support was preferable, since it was easier to represent rotation angles. It was also feasible to model the hoisting system of the crane as a local pendulum system. Since the angular changes and space displacements that captured from electric gyroscopes were relative values to the original positions of hoisters, there was no need to convert the local relative values back to a global system. After investigation and comparison, the local pendulum system was chosen to enhance the computational efficiency. Although the dynamics was more complicated, for improving productivity, the system was worth investigation. The resulting natural frequencies of structure and substructure for important modes were used in designing vibration neutralizers and counteracting gyroscopic torque. The dynamics of hoisting system was modelled as nonlinear rotation process based on the angular velocities that captured by the electrical gyroscope. The external forces can be determined and the designed actuator can provide counter balance force correspondingly to mitigate the rotation and displacement.

## 3.2 Design of Stabilizing System

In order to design a proper and applicable stabilizing system, the research developed multiple experiment prototypes for the testing purpose, at the same time, a simulation model was also introduced to validate the efficacy of the proposed system. Figure 3 illustrated the major prototypes we developed. Prototype 1 had a pure mechanical gyroscope with various load distribution cases. Prototype 2 was a boxed mechanical gyroscope to mimic the scenarios that the mechanical gyroscope is bounded with rigid mechanical systems instead of flexible cable. Prototype 3 was an electronic gyroscope to detected the three direction moments and rotations. The final prototype was a combination of mechanical system and electrical gyroscope to server as a stabilizer for the crane system.



## Prototype 1

The first prototype includes three different design of a mechanical gyroscope system. The system automatically stabilizes itself with an energy consumption motor to spin the mechanical core. The system was tested by fans to assess their ability of stabilization under various wind speed and load distributions.

**Table 1 Environment Settings for Prototype 1 Test**

Environment		
Height of gyroscope	41cm	
Temperature	22°C	
Average wind speed	13.09 m/s	
Total weight of gyroscope	345g	
Rotor spinning speed	12000 rpm	
Load		
	RPM 0	RPM12000 Angle of position 45°C
Without load	60s	20s

\* RPM means revolutions per minute

### (a) Case 1 Design



Figure 4 Field test of the Case 1 Design

Table 2 shows the list of stabilizing efficiency under various spinning speed. Wind velocity and test time are difficult to control. Both of the angle of gyroscope position and the rotor spinning speed have a certain influence to the stabilization.

**Table 2 Efficiency of Case 1 Design**

	RPM 0	RPM12000 Angle of position 90°C	RPM12000 Angle of position 75°C	RPM12000 Angle of position 45°C	RPM12000 Angle of position 15°C
With Load (weight 111.2g)	40s	30s	20s	15s	20s

**(b) Case 2 Design**

In the Case 2 design, motor is rested upper and the gyroscope fixed in rod. Under various wind, the stabilized load should have a cone type trajectory as shown in Figure 5.

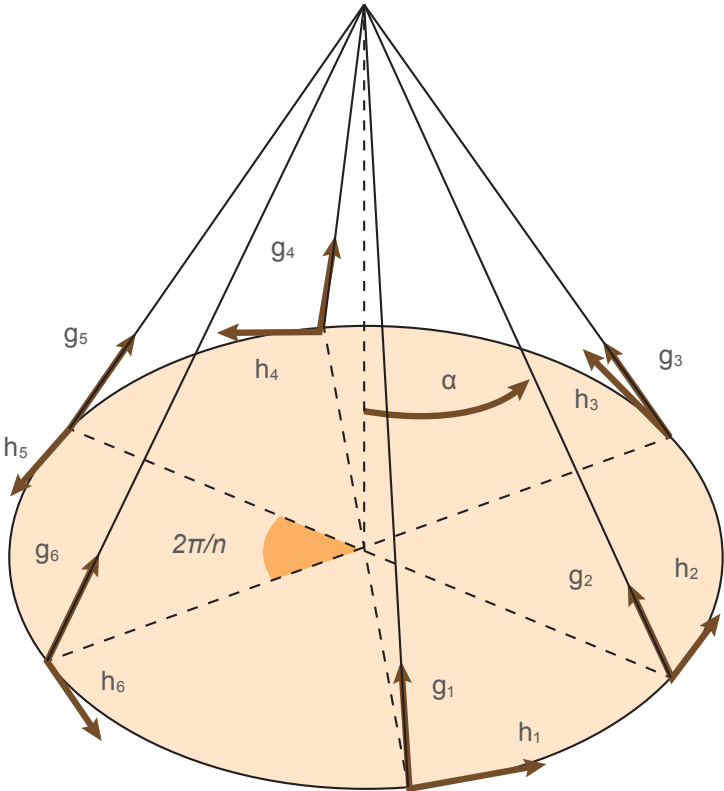

Figure 5 Trajectory of the Case 2 Design



Figure 6 Field test of the Case 2 Design

Wind velocity and test time are difficult to control. When given a force at any directions, it produces a cone type trajectory, which has a relative small swing magnitude.

**(c) Case 3 Design**

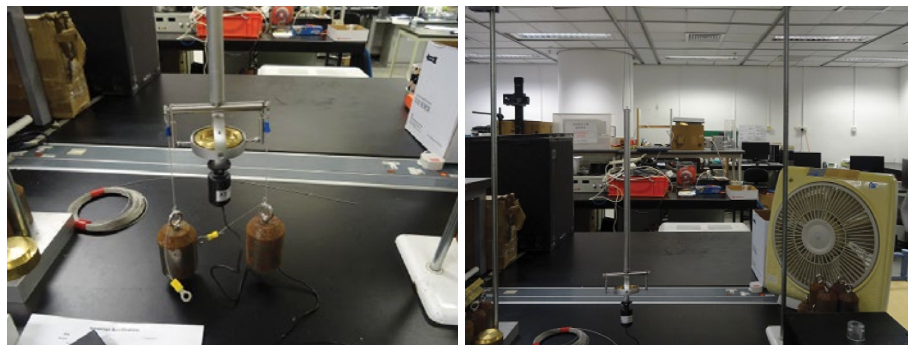

Figure 7 Field test of the Case 3 Design

When it swings at the direction of cross the bracket, the gyroscope of case 3 will not rotate. When it swings at the direction along the bracket, the gyroscope will rotate quickly. When it swings at two directions, the gyroscope will rotate at a certain angle, but there is no effect of stabilization for the rod and rope. The experiment results show the similar stabilization efficiency of Case 2 and 3 as the Case 1.

## Prototype 2

The second prototype includes two different design of a mechanical gyroscope system. A box was attached outside the stabilizing system. An electronic gyroscope and an ultrasonic sensor were also attached to the system to measure the displacement of the stabilizer. The systems would automatically stabilize themselves with input energy to spin the mechanical core. The system has been tested by fans to evaluate their ability of stabilization. Two cases were tested for prototype 2. Case 4 distributed the load of mechanical system horizontally along the wind direction, while the load was distributed vertically and perpendicular to the wind load in Case 5.

**Table 3 Environment Settings for Prototype 2 Test**

Environment		
Height of gyroscope	41.5 cm	
Temperature	22°C	
Average wind speed	20.11 m/s	
Total weight of gyroscope	345 g	
Ambient atmospheric pressure	485.2 Pa	
Rotor spinning speed	12000 rpm	
Load		
	RPM 0	RPM12000 Angle of position 45°C
Without load	60s	20s
With Load (weight 111.2g)	40s	15s

\* RPM means revolutions per minute

**(a) Case 4 Design**



Figure 8 Field test of the Case 4 Design

The stabilization of payload at Case 4 Design have an obvious effect with gyroscope spinning.

**Table 4 Test Results (Case 4) for Prototype 2 Test**

		Time (sec)					
Crane load with gyroscopic spinning	Swing direction	20	16	21	23	22	19
Crane load without gyroscopic spinning	Swing direction	Exceed 5 minutes					

**(b) Case 5 Design**

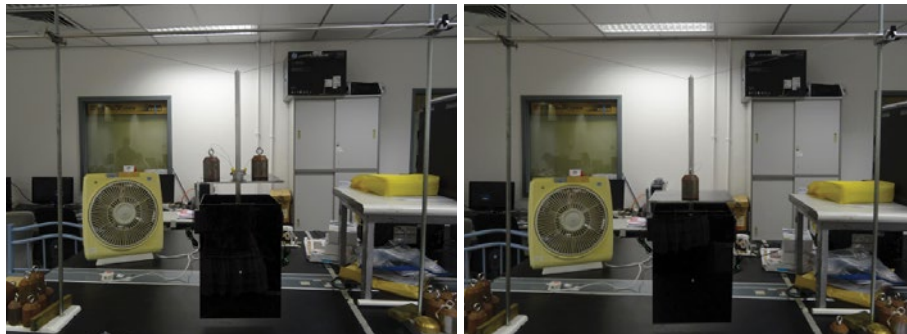

Figure 9 Field test of the Case 5 Design

Based on the test of Case 5 Design, we realize that the performance of the stabilization is not affected by the weight of hoisting load.

**Table 5 Test Results (Case 5) for Prototype 2 Test**

		Time (sec)			
Crane load as two weights	Swing direction-vertical beam(+)	32	21	22	20
	Swing direction-along beam(-)	13	9	22	N/A
Crane load as one weights	Swing direction(+)	18	35	61	N/A
	Swing direction(-)	13	23	13	N/A
Crane load as no weights	Swing direction(+)	20	23	37	31
	Swing direction(-)	26	34	34	19

### 3.3 Electrical Control System

Three controlling actions of the gyroscope were studied in detail and applied to construction cranes: gyroscope inertia, gyroscopic torque and oscillogyro. The gyroscope inertia was adopted to provide damping effects to the vibration (Leung 1987, 2001a; Leung and Cheung 1981). The gyroscopic torque induced by the spinning rotors and the swing of the girder were orthogonal to the spin and swing axes, and its intensity was proportional to the spin rate. An oscillogyro consisted of a slender beam attached at its center of mass by an elastic torsional spring to a gimbal. It was driven at high speed about its axis of spin. The natural frequency was directly proportional to the spin rate. By adjusting the spin rate according to the trolley position and the height of the cargo, one can tune the variable natural frequency of the crane system and stabilize it (Leung 1990, 2001b). The research team has tried various control strategies to make the stabilizer feasible. Also, the project modelled the translational swing and the horizontal rotation of the load during hoisting under high winds using gyroscopic moments.

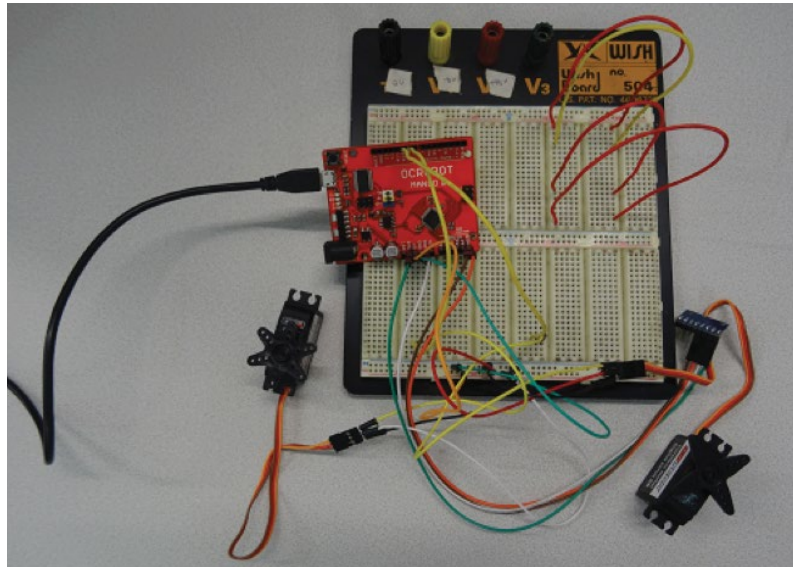

Figure 10 Sample development kit of an open source control system

In this research, the nonlinearity not only exists in converting the captured angular speed and movement of hoisters, but also the dynamic inputs of controller to stabilize the hoister and the outputs of counter balance movements for actuators. Therefore, this research utilized the captured real-time rotations and accelerations from electrical gyroscope as inputs to respond to the behavior of the hoisting system. Figure 11 shows a controller that relies on the electrical gyroscope to capture the rotation feedbacks and generate dynamic and calibrated inputs for the actuators.

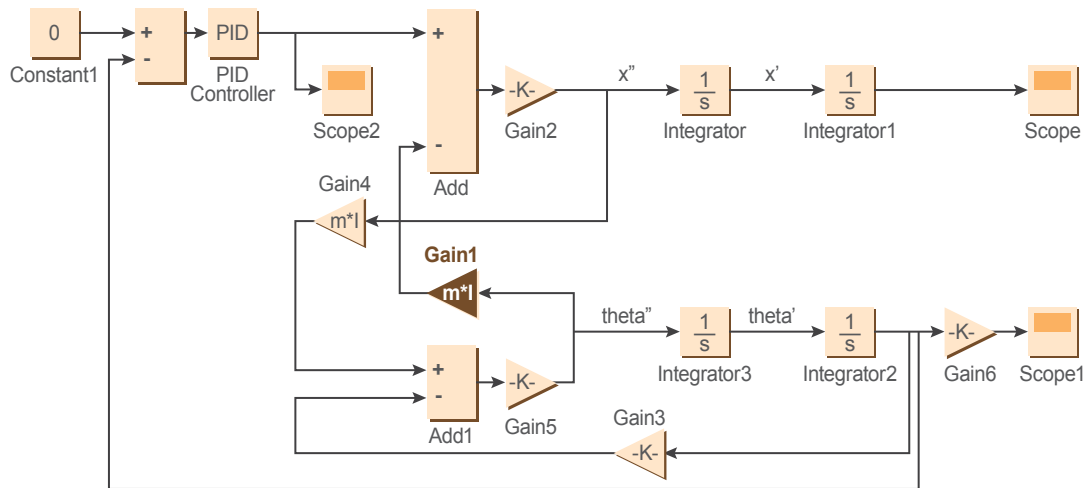

Figure 11 Control loop of simulation model

**Table 6 Environmental Wind and Position Orientation of Payload**

Time (sec)	Scalar Wind Speed (m/s)	Wind Direction (deg)	Swing Angular Velocity (deg/s)	Swing Angular Acceleration (deg/s <sup>2</sup> )	Payload Position Velocity x(m/s)	Payload Position Acceleration x(m/s <sup>2</sup> )
0	3.6	134	-5.36	-10.15	0.81	-6.10
5	3.8	133	-1.31	-5.25	0.62	0.65
10	3	131	-0.96	3.66	1.09	0.32
15	2.7	138	-5.15	11.88	1.98	7.55
20	1.5	85	2.68	10.91	2.24	1.57

### Hybrid Control System

Monitoring gyroscopic moments has been proven an effective approach to control the payload rotation. A suspender device with mechanical gyroscope could control load rotation under active and passive modes (Inoue *et al.* 1997). Although gyroscopes are valid tools for stabilization, a mechanical gyroscopic stabilizer is normally too heavy to carry. Therefore, great interest has turned up in the production of a low-cost, small size, and high accuracy electronic gyroscope (Nasir and Roth 2012).



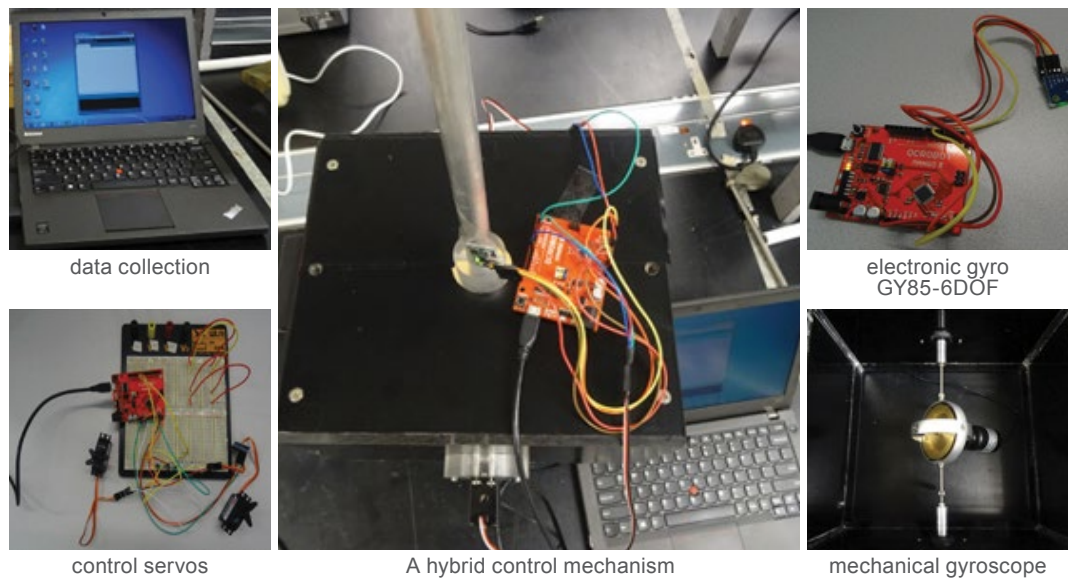

Figure 12 Platform of developed gyroscope stabilizer device

The project intends to design a light weight stabilizing system that combines mechanical and electronic gyroscopes, consisting of motor of mechanical gyroscope, gyroscope bracket, a rod to link the suspender part, and a black cloud platform to support fixture for the electronic and mechanical gyroscope as shown in Figure 12.

Among them, the electronic gyroscope tracks the real-time amplitude of the payload and the mechanical gyroscope implements the control scheme based on feedback data. The detail of hybrid control scheme diagram is shown in Figure 13. As shown in the figure, the developed system includes dual gyroscopes. With one mechanical gyroscope, the device could stabilize the oscillation in one direction, which along the fitting gimbal direction, namely roll direction. The dual gyroscopes configuration is a cross-shaped layout along roll and pitch directions, respectively.

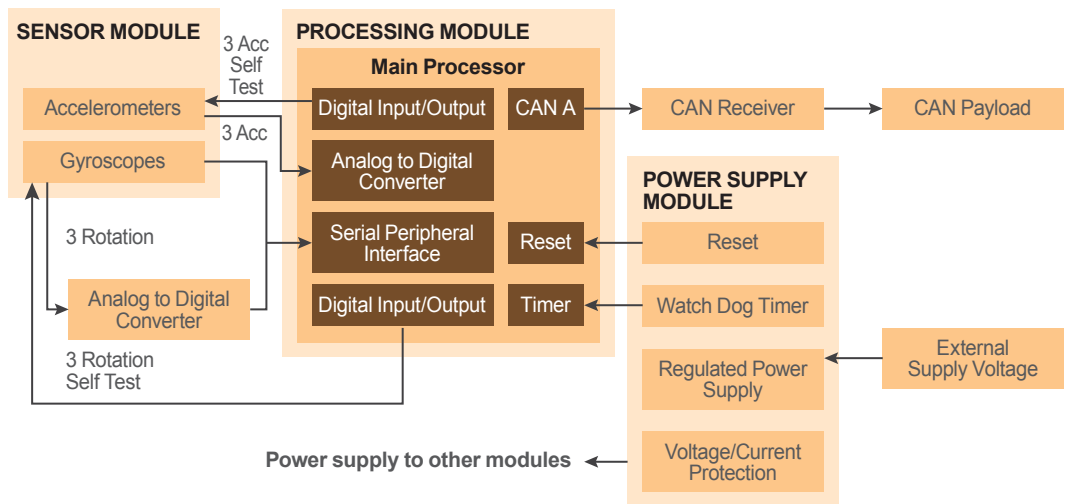

Figure 13 Control platform of the developed gyroscope stabilizer

### 3.4 Simulation for the Control System

The simulation showed that the hoisting system could exhibit significant pendulum dynamics under given crane payloads and rigging configurations. Under the environmental wind load, payload sway behaved as an inverted pendulum-type motion. There was no numerical solution of oscillation position and orientation under continuous wind force.

Therefore, a visual simulation model is composed to measure the four major parameters (swing angular velocity, swing angular acceleration, position velocity and position acceleration) under external wind disturbance. The simulation model of the pendulum-type hoisting system was created by MSC-ADAMS, as shown in Figure 14, in which rotary inertia is set as 0.006kg·m<sup>2</sup>. The mass of the rod is 0.2kg, and the length of rod is 400mm. The mass of the device is 0.5kg, and its dimension is 240mm x 220mm x 140mm.

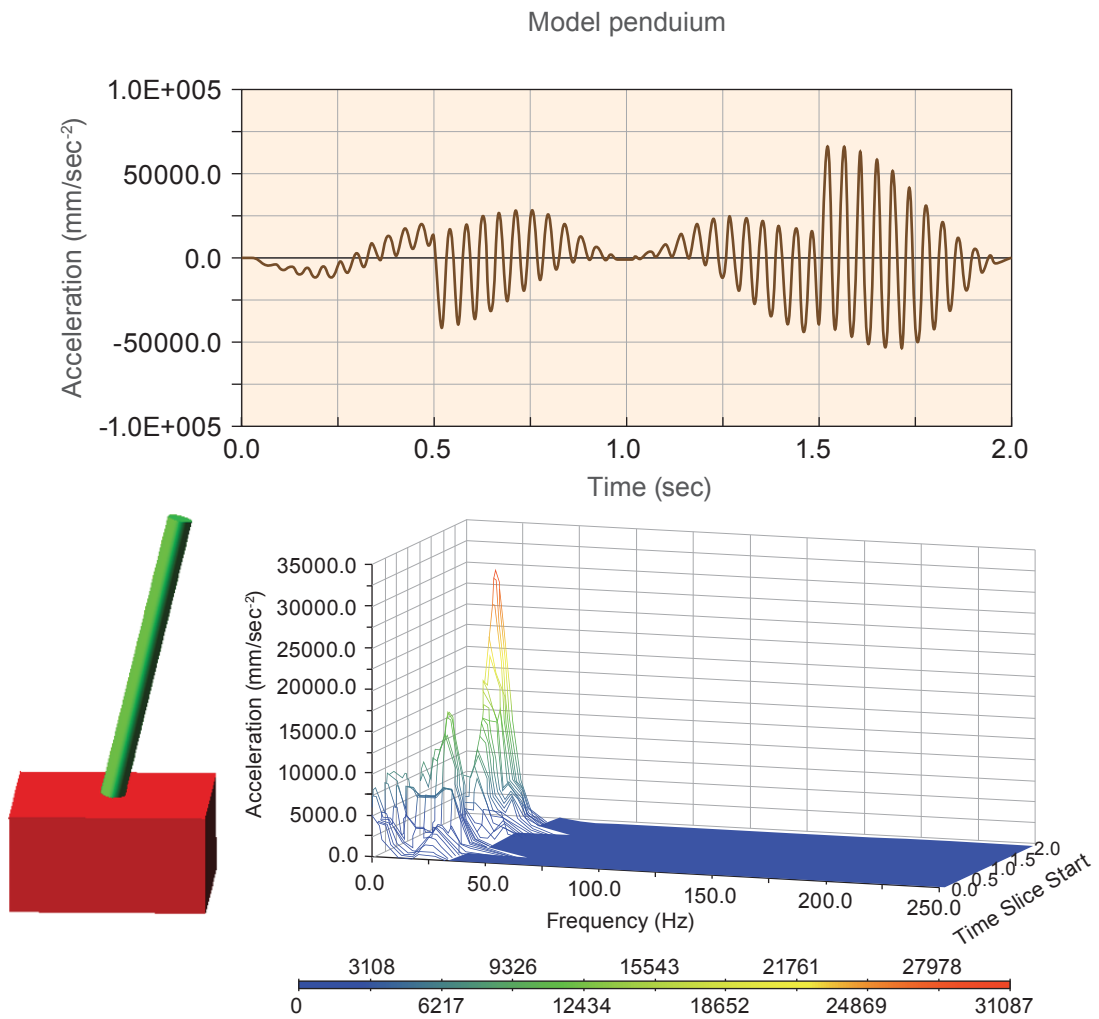

Figure 14 Simulation model of the pendulum-type hoisting system

Without wind load, the trend of velocity and acceleration of swaying angle is periodicity; while with wind load, the velocity and acceleration of swaying angle is gradually rising. So it is difficult to stabilize the payload oscillation when considering the environmental wind. In order to further compare simulation and wind tunnel test, the simulation model mimics the scalar wind speed and wind direction in Baker City in US. From the dynamic simulation of the pendulum type hoisting system, the angular velocity and angular acceleration of oscillation due to the continuous wind speed can be calculated out, as shown in Table 6. Then the position and orientation of payload can be identified through the expression of state space of the inverted pendulum system (Precup *et al.* 2012). Therefore, the relationship between oscillation position and environmental wind force in pendulum-type hoisting system is established.

### 3.5 Design of the Final Prototype

The final prototype of the gyroscopic stabilizer includes both electrical and mechanical gyroscope to maintain the payload status, also, steam jets are installed to cancel out the unbalanced displacement.

Figures 15-16 show the design of the major components of the stabilizer. The final integrated design forms a closed control loop using inertia measurement units (IMUs) and ultrasonic sensors to capture the system feedback. The mechanical system automatically restores the pitch, roll and yaw caused by unbalance the external force. At the same time, IMUs automatically adjust the ejection rate of the steam system to maintain the transition of the stabilized. The system could also update its setting points automatically based on the sensor's feedback. Figure 17 shows the final integrated stabilizer.

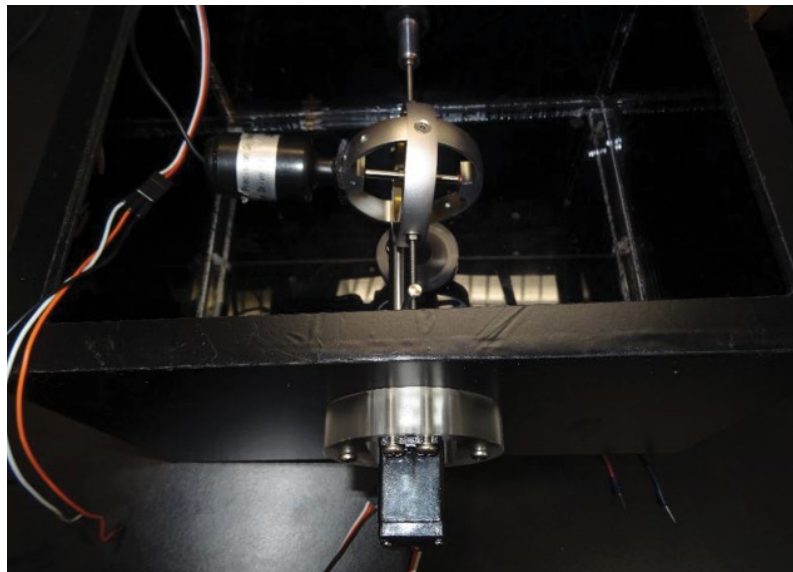

Figure 15 Mechanical gyroscope of the developed system

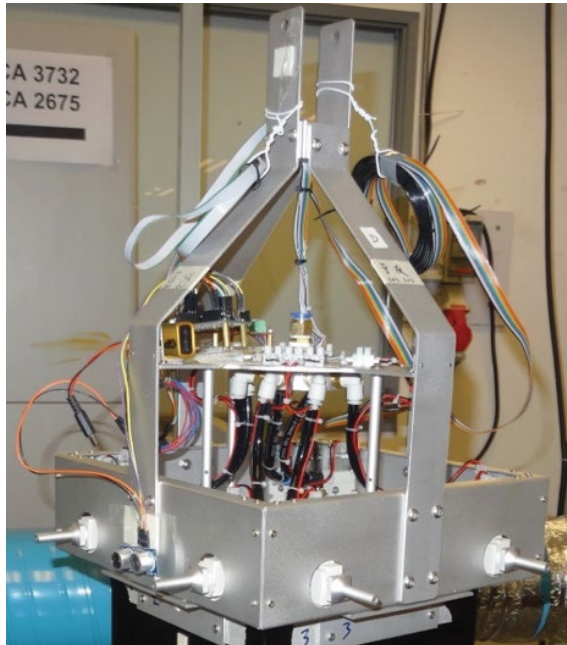

Figure 16 Electrical gyroscope of the developed system

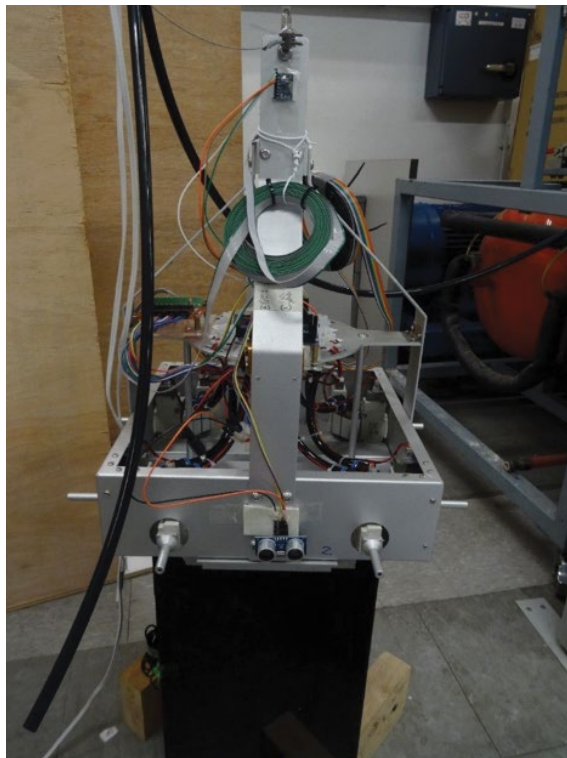

Figure 17 Integrated gyroscopic stabilizer

# 4 CONCLUSION AND RECOMMENDATIONS

## 4.1 Conclusion

It is extremely difficult to stabilize the hook and payload due to suspend status under environmental wind disturbance. In this research, the hoisting system of tower crane is treated as a pendulum, which allows oscillation to occur during crane motion. Computer-based simulation is created in this report to optimize the payload position and orientation under the environmental wind. The simulation proves that the pendulum system can reduce the oscillatory amplitude of the payload with the proposed hybrid control mechanism of combining mechanical and electronic gyroscope.

In the hybrid system, the electronic gyroscope tracks the real-time amplitude of payload, and the mechanical gyroscope is utilized as an actuator to produce a balancing torque and keep crane payload in a stable state. An experiment has been conducted to validate the integrated device. Wind tunnel test results suggest that comparing to traditional control system, our proposed hybrid control mechanism is a more efficient method which can stabilize the payload faster and optimize installation angle of mechanical gyroscope.

## 4.2 Recommendations

In summary, this research provides following recommendations for the practical implementation of the proposed gyroscopic stabilizer:

1. The gyroscopic stabilizer could remain stable under fluid flow associated with propulsion of the body passes in a predetermined direction.

A bearing mounting the ring rotationally on the body with the ring disposed for passage of the fluid axially of the ring. Rotation of the crane mounting could be gyroscopically stabilized the body through the mechanical gyroscope.

2. The investigation of computer simulation suggests the crane movement could be minimized through the calculation of the inertia.

With the computational modeling, the hoisting system can be modeled as a spherical system using spherical coordinates in the case of stationary motion. Through the calculation of the rotation matrix, the movement of hoisting system could be controlled.

3. The design of the stabilizer has been tested in multiple cases; an enclosed box with mechanical gyroscope could improve the system stability.

When it swings at the direction along the bracket, the gyroscope will rotate quickly. When it swings at two directions, the gyroscope could rotate at a certain angle without effect of stabilization for the rod and rope. The validation experiment suggests, when the fluid flow comprises gases exiting from wind tunnel disposed in propulsive relation to the body of the stabilizer, the steam jet mounted on the body could response radially to the tabulation even in two different directions.

Therefore, the installation the proposed system could effectively stabilize the crane hoisting system rapidly with proper electronic system installed.

For future research, the report suggests following directions:

1. Investigating the stability of tower crane at height, especially for skyscraper construction, since the air pressure and wind speed could change dramatically.
2. Dynamic stabilization of the hoisting system. The current system assumes the developed gyroscope could stabilize the crane in a 2D space. However, when the hoisting system is in operation, the wind speed could dynamically change when the load goes up or down. The behavior of the hoisting system is much complicated and uncertain.



# 5 REFERENCES

Abdel-Rahman, E. (2003). "Dynamics and control of cranes: A review." *Journal of Vibration and Control*, 9(7), 863–908.

Chen, Y., and Leung, A. (2012). *Bifurcation and chaos in engineering*.

Collado, J., Lozano, R., and Fantoni, I. (2000). "Control of convey-crane based on passivity." *Proceedings of the 2000 American Control Conference. ACC (IEEE Cat. No.00CH36334)*, IEEE, 1260–1264.

Ding, Q., Leung, A., and Cooper, J. (2001). "Dynamic analysis of a self-excited hysteretic system." *Journal of sound and vibration*, 245(1), 151–164.

Ge, T., and Leung, A. (1998). "Construction of invariant torus using Toeplitz Jacobian matrices/fast Fourier transform approach." *Nonlinear Dynamics*, 15(3), 283–305.

Inoue, F., Watanabe, K., and Ikeda, Y. (1997). "A practical development of the suspender device that controls load rotation by gyroscopic moments." *Proceedings of the 14th International Symposium on Automation and Robotics*, 8.

Leung, A. (1978). "An accurate method of dynamic condensation in structural analysis." *International Journal for Numerical Methods*, 12(11), 1705–1715.

Leung, A. (1987). "A simple method for exponentially modulated random excitation." *Journal of Sound and Vibration*, 112(2), 273–282.

Leung, A. (1990). "Non-conservative dynamic substructures." *Dynamics and Stability of Systems*, 5(1), 47–57.

Leung, A. (1991). "Dynamic stiffness analysis of follower moments." *Computer-Aided Civil and Infrastructure Engineering*, 6(3), 229–236.

Leung, A. (1992). "Nonlinear modal analysis of frames by the incremental harmonic-balance method." *Dynamics and Stability of Systems*, 7(1), 43–58.

Leung, A. (1993). "Non-conservative dynamic stiffness analysis of axial-lateral buckling." *Journal of Sound and Vibration*, 165(3), 553–561.

Leung, A. (2001a). "Dynamic stiffness for structures with distributed deterministic or random loads." *Journal of Sound and Vibration*, 242(3), 377–395.



- Leung, A. (2001b). "Fast matrix exponent for deterministic or random excitations." *International Journal for Numerical Methods in Engineering*, 50(2), 377–394.
- Leung, A., and Fung, T. (1990). "Geometrically non-linear vibration of spinning structures by finite element method." *Journal of Sound and Vibration*, 139(1), 43–62.
- Leung, A., and Rajendran, S. (1996). "Global bifurcation of a three-hinged rod subject to a kind of follower force." *Computers & Structures*, 58(3), 513–534.
- Leung, A. T., and Rajendran, S. (1996). "Symmetry and bifurcation of a three-hinged rod." *International Journal of Bifurcation and Chaos*, 6(12a), 2401–2409.
- Leung, A., and Zhang, Q. (1998a). "Higher order normal form and period averaging." *Journal of Sound and Vibration*, 217(5), 795–806.
- Leung, A., and Zhang, Q. (1998b). "Complex normal form for strongly non-linear vibration systems exemplified by Duffing–van der Pol equation." *Journal of Sound and Vibration*, 213(5), 907–914.
- Leung, Y. (1983). "Fast modal response method for structures." *International Journal for Numerical Methods in Engineering*, 19(10), 1435–1451.
- Leung, Y., and Cheung, Y. (1981). "Dynamic analysis of frames by a two-level finite element method." *Journal of Sound and Vibration*, 74(1), 1–9.
- Nasir, A., and Roth, H. (2012). "Pose Estimation by Multisensor Data Fusion of Wheel Encoders, Gyroscope, Accelerometer and Electronic Compass." *Embedded Systems, Computational Intelligence and Telematics in Control*, 1, 19–54.
- Precup, R., Radac, M., and Filip, H. (2012). "Signal processing in iterative improvement of inverted pendulum crane mode control system performance." *Instrumentation and Measurement Technology Conference (I2MTC)*, 812 – 815.
- Ravindra, B., and Mallik, A. (1993). "Hard Duffing-type vibration isolator with combined Coulomb and viscous damping." *International Journal of Non-linear Mechanics*.
- Richards, T., and Leung, Y. (1977). "An accurate method in structural vibration analysis." *Journal of Sound and Vibration*, 55(3), 363–376.

---

Sedaghat, A., and Cooper, J. (2001). "Estimation of the hopf bifurcation point for aeroelastic systems." *Journal of Sound and Vibration*, 248(1), 31–42.

Sedaghat, A., and Cooper, J. (2002). "Limit-cycle oscillation prediction for non-linear aeroelastic systems." *Aeronautical Journal*, 106(1055), 27–32.

Winn, R., Slane, J., and Morris, S. (2005). *Aerodynamic Effects in the Milwaukee Baseball Stadium Heavy-Lift Crane Collapse*.



## Members of CIC Task Force on Research

Mr. Jimmy TSE  
Prof. Christopher LEUNG  
Ir Joseph MAK  
Prof. James PONG  
Prof. Sze-chun WONG  
Ir Chi-chiu CHAN  
Ir Tommy NG  
Mr. Shu-jie PAN

## Research Team

### Principal Investigator

Dr Jiayu Chen

### Former Principal Investigator

Prof. Andrew Y.T. Leung

### Co-Investigator

Dr Xiaowei Luo

### Research Coordinator

Dr Bin Ren

### Research Assistants

Wong Shuk Ching  
Cheung Sau Kwan  
Wong Kwun Wah  
Li Ka Wing  
Yang Yi  
Tan Tianfeng  
Fan Baowei  
Wong Ying Kit

### Students Helper

Ganegama Bagobage Sakura  
Law Wai Ho Allen  
Kuan Ka Hin  
Liu Ho Yin

### Industrial Collaborators

Hong Kong EMSD  
Transport Department of  
HKSAR Government  
Hoi Keung Design  
Yau Lee Construction  
Company Limited  
Housing Department of  
HKSAR Government

建造業議會  
Construction Industry Council

Address 地址 38/F, COS Centre, 56 Tsun Yip Street, Kwun Tong, Kowloon  
九龍觀塘駿業街56號中海日升中心38樓

Tel 電話 : (852) 2100 9000

Fax 傳真 : (852) 2100 9090

Email 電郵 : enquiry@cic.hk

Website 網址 www.cic.hk



[cic\\_hk](https://www.instagram.com/cic_hk)



[HKCIC](https://twitter.com/HKCIC)



[Construction Industry Council](https://www.linkedin.com/company/construction-industry-council)



[CICCHK](https://www.facebook.com/CICCHK)



[HKCIC](https://www.youtube.com/HKCIC)



[Construction Industry Council Hong Kong](http://www.cic.hk)

Copyright © Construction Industry Council

All rights reserved. No part of this publication may be reproduced, stored in a retrieval system, or transmitted in any form or by any means, electronic, mechanical, photocopying, recording or otherwise, without the prior written permission of the publisher